

FRIES®
rack
system



DISHWASHER RACKS

500 x 500

EN

Gastro rack systems for all needs

»The innovative FRIES rack system sets the standard.«

The needs of the hotel, restaurant and catering industry continually grow, and ever more products are on the market. That is the case for glasses, plates, trays and other pieces that have to be washed.

Whatever your needs may be, we definitely have the right rack for you.



Clixrack 500 Glass Rack

racks in standard heights

Page 07–09



Customrack 500 Glass Rack

custom-made racks

Pages 11–13



Basys 500 All-Purpose Rack

for washing different tableware

Pages 14–15



Base Rack 500

for all types of tableware

Pages 16–18



Logistics and Accessories

for transport and storage

Page 19

Advantages

of the FRIES 500 rack system

Pages 03–05

Advantages of the FRIES rack systems

Clixrack 500

CLIX and it's ready!

Simple assembly without tools, available in 11 standard heights from 73 to 260 mm.

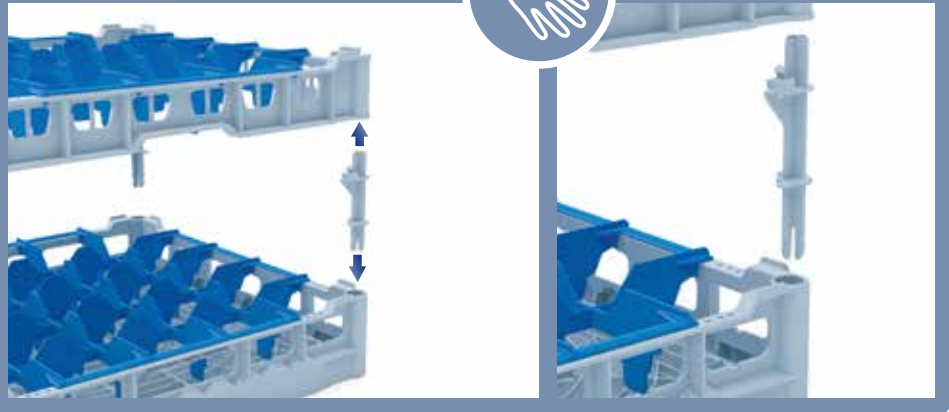

Customrack 500

A rack that takes the measure of every glass!

The height of the rack can be precisely adjusted and customized to the height of the glasses.

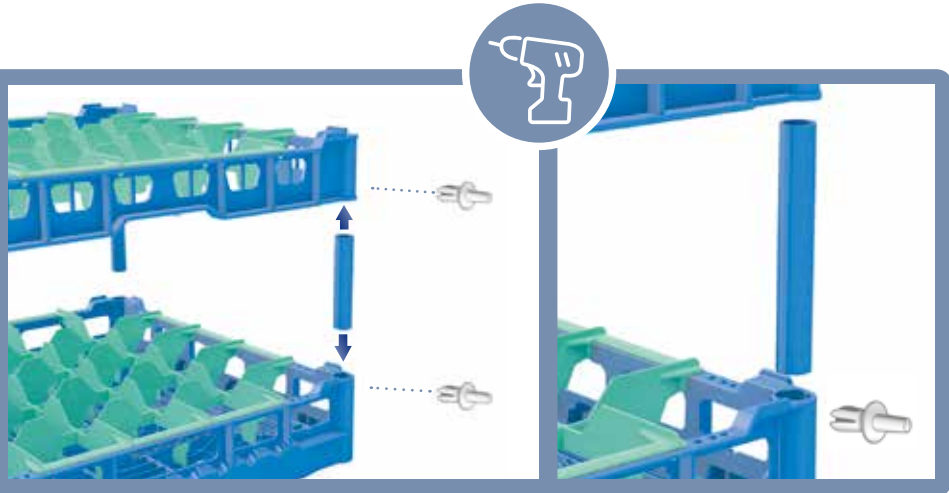

Less glass breakage and open design

The open rack design ensures water access for a better washing result. Also the glasses dry more quickly. At the same time, the glasses are optimally protected, and the racks can be easily stacked.



Rack system 500
All the advantages
of the rack systems:
www.fries-kt.com



Tilted glasses

The racks can be fitted with tilting clips at customers' request. This allows water to better drain from the bottom of the glasses.



Lightweight and ergonomic

The edges are rounded, and the racks can be easily and comfortably held with the side handles. The racks are lightweight, and their contents can be easily checked.

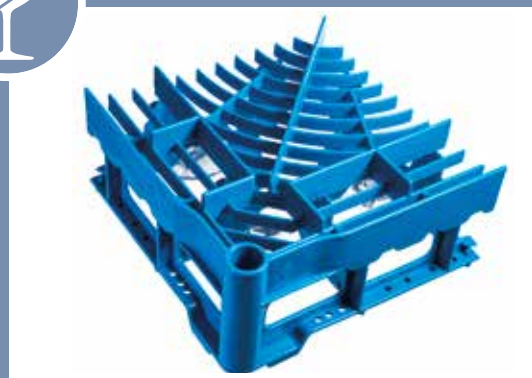

Duplex bottom

Two bottom levels: the rack's upper bottom holds the items being washed, while its lower bottom serves as a cross piece, ensuring better stability during transport. Less sagging, fewer unwashed spots (narrower webbing) and no damage to the contents from transport hooks.

Choosing the right rack



Measuring chart request our measuring chart here! www.fries-kt.com



Extra Service: Choosing the right rack with the FRIES measuring chart

You can easily find the right type of rack with the help of the FRIES measuring chart. The chart makes it easy to choose the correct compartment size and rack height.

Colour coding and branding



The coloured compartments can be combined with seven different frame colours, making it easy to place glasses in the right rack.



You can also individually design and label your racks by **hot foil embossing** your lettering or logo.



Coding clips in different colours serve as another way to differentiate your glass racks, which can also be embossed.

Other advantages at a glance

- » sturdy and long-lasting
- » stackable
- » polypropylen as approved food compliant material
- » easy to grasp the bottom of glasses when removing them

Gastro Norm runners 530 x 500 mm



Upon customers' request, the FRIES Rack System glass racks are also available as Gastro Norm racks with dimensions of 500 x 530 mm. The side runners make it possible to slide the racks right into Gastro Norm slots. For those racks, the basic rack NK is used with rectangular bottom structure and EWD.

Efficient Wash Design Plus (EWD+)

EWD+ is a further development of the tried and tested Efficient Wash Design (EWD). This patented technology ensures the circulation of the water jet directly onto the critical sections at the rim of the glass or plates held in the first and last rows, respectively.

Even better washing results are achieved thanks to the new, unique open structure of the rack's base, including added details for targeted water deflection directly from the rotating washing arms.

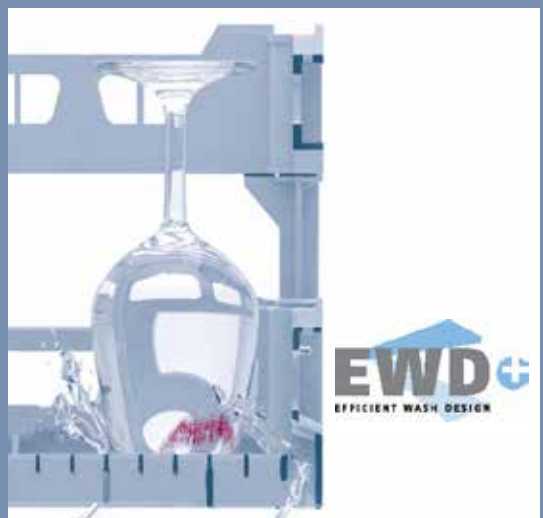



Bright ideas...

... set brilliant standards

Clixrack 500 glass rack the flexible standard

»The rack for your glasses in standard sizes. The ideal solution for transporting, storing and washing the most common types of glasses.«

Our racks can be adjusted to fit your glasses through the use of different Clix extenders, providing a high degree of flexibility. You can easily assemble the racks yourself.

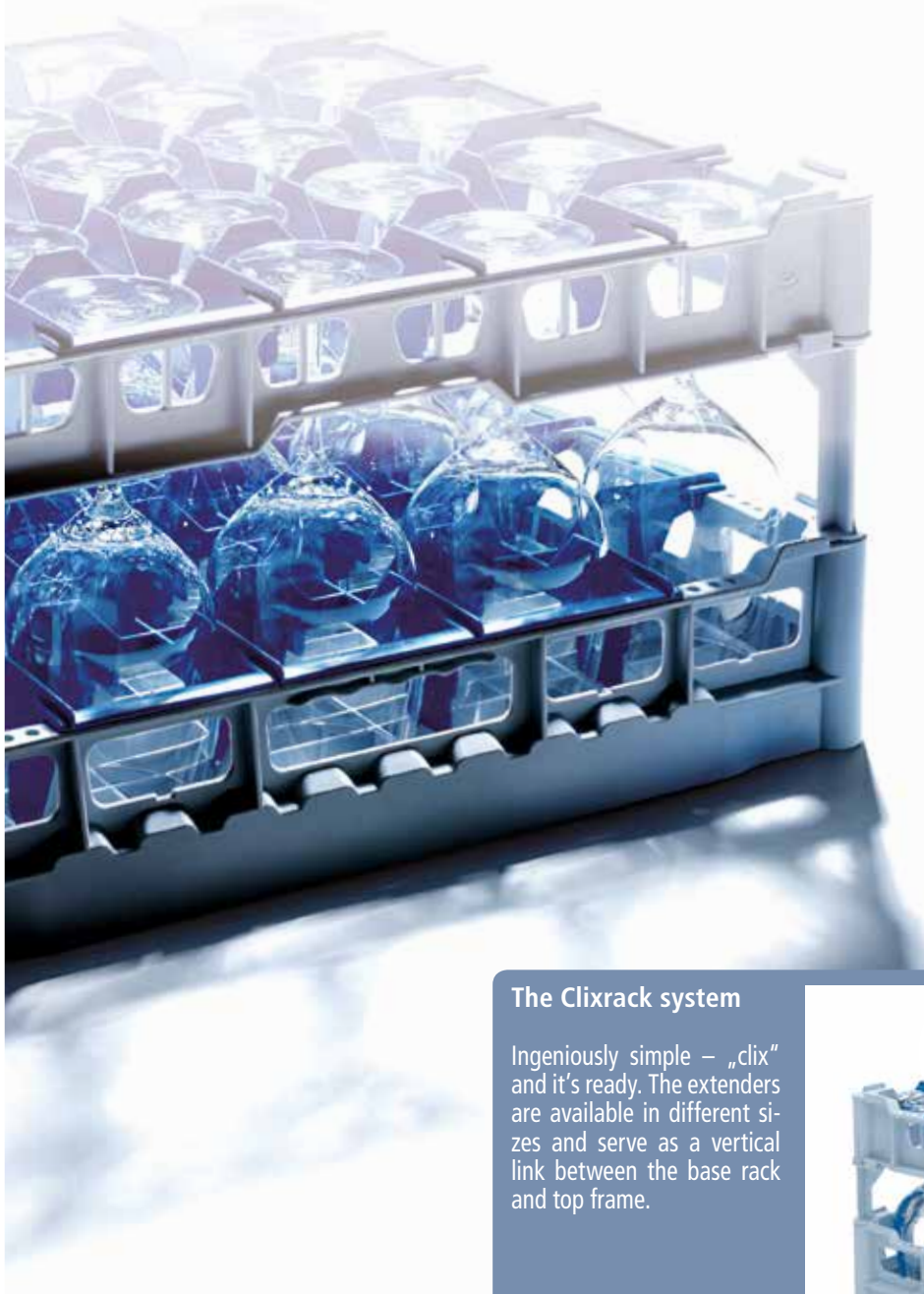

Clixrack 500 ... at a glance

- » Efficient Wash Design Plus (EWD+)
- » stackable
- » lightweight
- » convertible
- » easy checking of rack contents
- » colour-coded compartments
- » good carrying comfort

The Clixrack system

Ingeniously simple – „clix“ and it's ready. The extenders are available in different sizes and serve as a vertical link between the base rack and top frame.



Clixrack glass racks

The different rack types are each exemplarily shown with a compartment for 25 glasses.

Rack types for glass heights up to:

73 mm (A)



120 mm (I)



140 mm (K)



155 mm (IH)



170 mm (KH)



185 mm (NH)



200 mm (MH)



215 mm (OH)



230 mm (LH)



245 mm (PH)



260 mm (IKH3)



Compartments

for 16 glasses (4 x 4)
max. glass diameter
113 mm

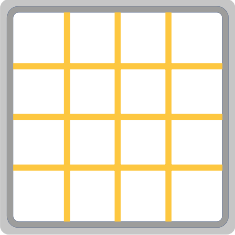

for 20 glasses (20)
max. glass diameter
99 mm

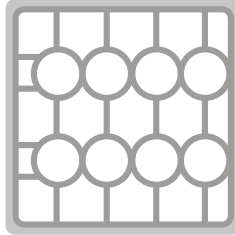

for 25 glasses (5 x 5)
max. glass diameter
90 mm

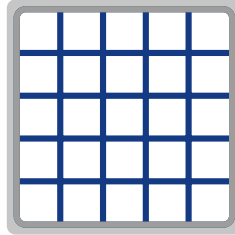

for 30 glasses (30)
max. glass diameter
81 mm

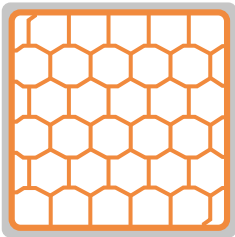

for 36 glasses (6 x 6)
max. glass diameter
74 mm

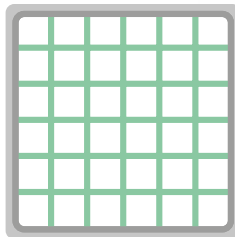

for 44 glasses (44)
max. glass diameter
67 mm

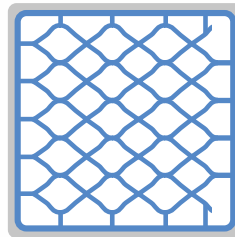



A rack customized to your glass!

Customrack 500 glass rack custom-made for your glasses

»The customized rack. The made-to-order solution for safely storing, transporting and washing all of your glasses.«

The modular construction of the glass racks in combination with the different colours of the components makes these racks an indispensable part of a modern tableware management system. The design brings current operating costs under control and minimizes labour requirements as the use of resources such as detergent and energy.



Customrack 500 ... at a glance

- » Efficient Wash Design Plus (EWD+)
- » stackable
- » lightweight
- » easy checking of rack contents
- » coloured covering frames
- » good carrying comfort
- » less glass breakage due to customized rack assembling
- » optional tilting of glasses
- » optional Gastro Norm runners (see description page 05)

Custom-made racks

The tube extender can be cut to any height. It connects the base rack and frame and is fixed with plastic rivets.

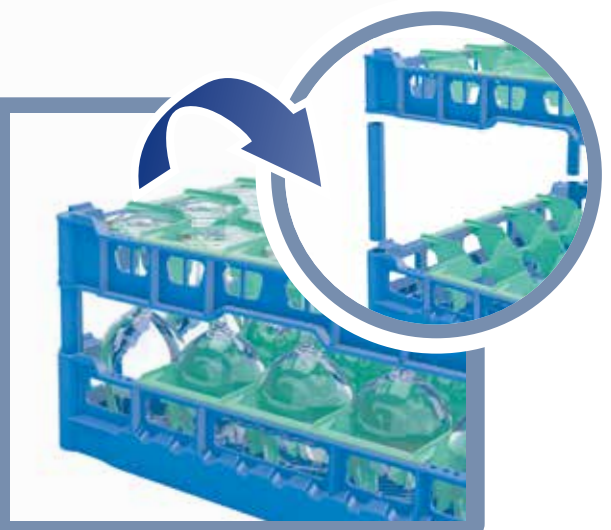

Customrack glass racks

The different rack types are each exemplarily shown with a compartment for 36 glasses.

Rack types for glass heights up to:

73 mm (A)



100, 110, 120, 130 mm (B)



110, 120, 130 mm (B2)
for stemware



140, 150, 160 mm (C)



170, 180, 190, 200, 210, 220,
230 mm (CH)



210, 220, 230, 240 mm (D)



210, 220, 230, 240 mm (DH)

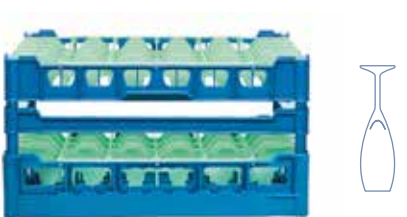

220, 230, 240, 250, 260,
270 mm (D3)



220, 230, 240, 250, 260,
270 mm (DH3)



Compartments

for 9 glasses (3 x 3)
max. glass diameter
150 mm

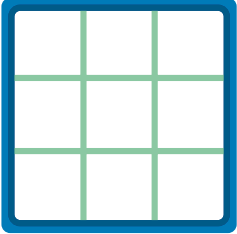

for 16 glasses (4 x 4)
max. glass diameter
113 mm

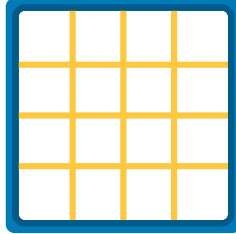

for 20 glasses (20)
max. glass diameter
99 mm

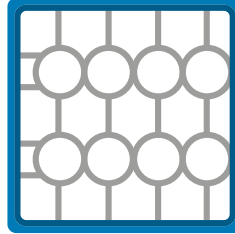

for 25 glasses (5 x 5)
max. glass diameter
90 mm

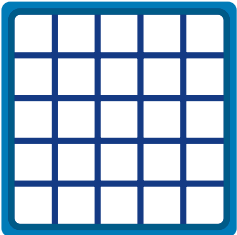

for 30 glasses (30)
max. glass diameter
81 mm

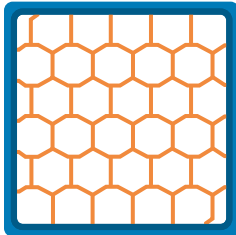

for 36 glasses (6 x 6)
max. glass diameter
74 mm

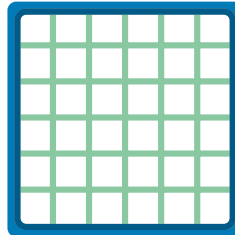

for 44 glasses (44)
max. glass diameter
67 mm

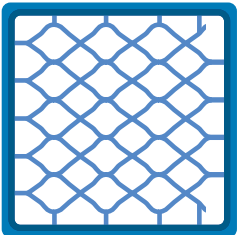

for 49 glasses (7 x 7)
max. glass diameter
63 mm

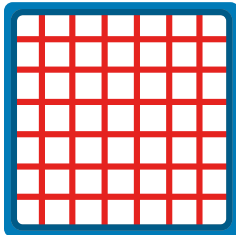

for 20 glasses (4 x 5)
compartment size
113 x 88 mm

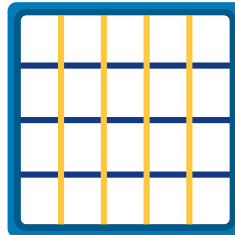

for 35 glasses (5 x 7)
compartment size
88 x 63 mm

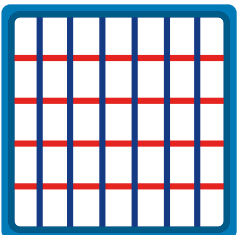

Basys 500 the ideal general purpose rack

»The universal rack for glasses, cups, plates and cutlery.«

Our all-rounder, the Basys 500 is the general purpose rack for multiple uses – ideal for bars, cafés and restaurants. An open bottom and efficient circulation of water over and around items in the interior of the rack lead to perfect washing results.

Basys 500 ... at a glance

- » Efficient Wash Design Plus (EWD+)
- » modular rack
- » tilting of glasses
- » secure locking with Glasrelax inserts
- » high sidewalls
- » open design
- » less glass breakages

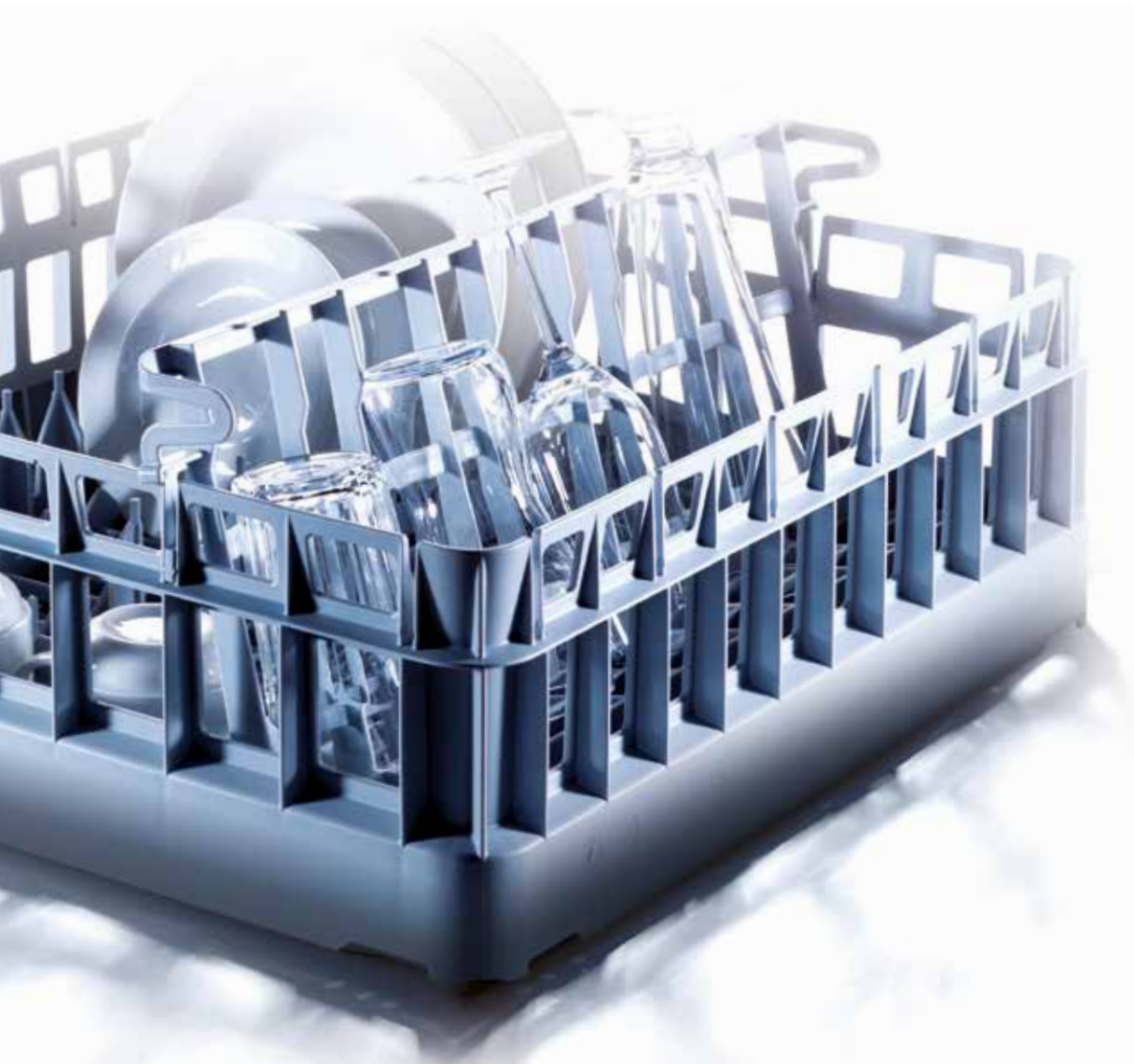

Base rack and examples of use

Base rack (R500)

high sidewalls prevent items being washed from falling out
500 x 500 x 174 mm,
interior height: 150 mm

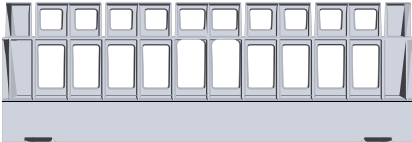

Combination rack (R500 combi)

with glasrelax insert, plate insert
and cutlery holder



Glass rack (R500-4GR)

base rack with 4 Glasrelax inserts
first row: max. diameter 110 mm
rows 2-4: max. diameter 95 mm



Glass rack (R500-5GR)

base rack with 5 Glasrelax inserts
first row: max. diameter 95 mm
rows 2-5: max. diameter 75 mm



Accessories and available inserts

Plate insert (PI 400)

for washing 9 plates with diameters
up to approx. 24 cm,
plate insert is removable



Cutlery holder (CBS)

pyramid-shaped base
to better separate the cutlery



Drip tray (AWAT 500)

drip tray for the counter



Glasrelax insert (GR500)

for holding glasses in a tilted position



The indent of the Glasrelax guarantees that glasses are securely held in a tilted position and reduces glass breakage. Water drains out better from the bottom of the tilted glasses.



Base racks 500 for all types of tableware

Plates, cups, cutlery, etc. – we have the right washing rack for every piece of tableware. The open design and EWD+ ensure optimal washing results. Additionally, plate racks are equipped with specially designed pegs to prevent the plates from falling over.



Base racks 500 ... at a glance

- » Efficient Wash Design Plus (EWD+)
- » pyramid-shaped base grid for cutlery baskets
- » special designed pegs on plate racks
- » one rack – for both soup plates and dinner plates
- » bottomless rack P15 for large plates

Base racks

Wide-meshed base rack (NK+)



Raised NK+ base rack (NK 110+) inside dimension 110 mm



Raised NK+ base racks (KH 170+) inside dimension 170 mm additional heights available



Plate racks

Plate rack (P-18-12+)
for 18 dinner plates



or 12 soup plates



A rack for dinner and soup plates
(rotated 90°)



Plate rack (UK)
for 16 dinner or 12 soup plates



Plate insert (PTE)
made of rilsan-coated wire, holds 9
large plates, suitable for base rack NK+
(distance between rows: 37 mm)



Plate rack (P 15)
bottomless rack for 15 large dinner
and soup plates, with diameters
of at least 18 cm



Cup racks

Cup rack (E 4x5/65)
for 20 cups, with tilting
compartment size: 88 x 113 mm



Retaining grid (NHG 500 / NHG 460)
500: sits on the rack
460: sits on the items being washed



Cup insert (TE3, TE4, TE5)
made of rilsan-coated wire
3 rows - 16 cm layer
4 rows - 10 cm layer
5 rows - 8 cm layer



Cutlery racks

Cutlery rack (BK)
narrow-meshed



Cutlery holder (CBS)
with a pyramid shaped base



fits into plate rack P-18-12+



Cutlery carrier (CBS 4)
with pyramid-shaped base



Silverstar cutlery rack (BKS)
with handles, 2 units fit into base rack NK+,
with pyramid shaped base



ideal water access and pyramid base



Tray racks

Tray insert (NKT)
rilsan-coated wire, for 9 large trays,
cut out on one side for base rack NK+
(distance between rows: 39 mm)



Tray insert (UKT)
plate rack for 8 large trays,
reinforced with stainless steel rails



Tray basket (T-06-09)
for 8 trays



Tray Insert (GN 1/1)
Rilsan-coated wire, for 9 large trays,
cut out on two sides to fit into base rack
NK+ (distance between rows: 37 mm)



**Thermo Insulated Tray Insert
(WHT 4/WHT 5)**
Inserts of stainless steel wire
For 4 trays, distance between rows 95 mm
For 5 trays, distance between rows 75 mm



Logistics and accessories: Secure transport and storage of glass racks



Drip tray (AWAT 500)
 lower drip tray,
 suitable for counters -
 can also be used as cover



Double rack platform cart (DROLB 500)
 for the transport and storage of glass
 racks stacked side by side, with two push
 bars and removable drip trays



Cover (ABH 500)
 1.60 m high, to protect your glasses



Platform cart (ROL 500)
 with removable drip tray
 and four casters



Platform cart with push bar (ROLB 500)
 with removable drip tray
 and four casters



Rack systems 500

The product line includes diverse solutions for washing glasses, plates and cutlery in commercial dishwashers, in addition to transport and storage.

No one offers more options than we do!



Rack System 500 x 500
Additional information about the FRIES Rack System 500 product line is available at:
www.fries-kt.com

Have you seen these?

Learn about the range of our products.



Rack system 400x400

for small undercounter dish- and glasswashers



Rack system 600 x 400

for the logistics, glass hire and catering business



Rack system 600 x 500

for large hood-type and rack conveyor machines



Gastro & Catering

Transport boxes and party plates



Reusable tableware

for sustainable events & to-go meals



FRIES Kunststofftechnik GmbH

Schützenstraße 19, 6832 Sulz, Austria
Tel.: +43(0)5522 4935 201, Fax: + 43(0)5522 4935 209
info@fries.at, www.fries-kt.com



Packaging



Gastro



Industry racks



Moulding