

**FRIES**®  
**rack**  
system



**DISHWASHER RACKS**

**400 x 400**

EN

# Intelligent gastro racks

"The innovative FRIES rack system sets the standard."

With its complete rack system, FRIES offers bistros, bars, cafés and restaurants an all-round solution for storing, transporting and washing glasses and cups.

Whatever your requirements are – we definitely have the right rack for you.



---

## Advantages

Rack system L 400 x 400

Page 3

---



### Rack system L 400

for storage, transport and washing

Page 4 - 5

---



### Logistics and accessories

for transport and storage

Page 5

---



### Rack system R 400

the all-round solution for washing

Page 6 - 7

---

# Advantages rack system L 400

## Available rack widths

390 x 390 mm  
396 x 396 mm

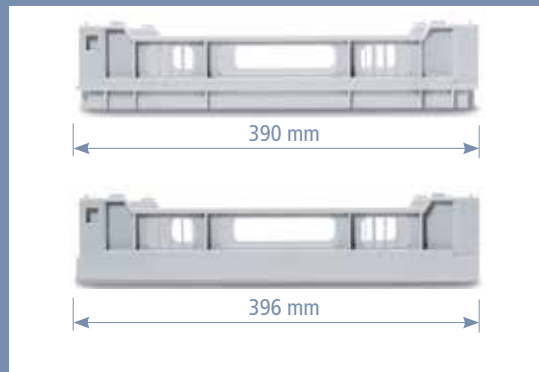

## Tilting position

The glasses and cups can be tilted using the terrace insert. This enables even better cleaning results.

## Colour-coded corner profiles



Corner profiles are available in various colours to quickly match the glass and the suitable rack.

## Easy rack measurement



### Extra service: Rack measurement with the FRIES measuring chart

The FRIES measuring chart helps you to find the right rack type easily. Using the measuring chart, the suitable compartment division and height of the glasses can be identified easily.



Measuring chart  
Request our measuring chart here!

[www.fries-kt.com](http://www.fries-kt.com)



# Rack system L 400

**"The ideal solution for cleaning, storage and transport."**

The 400 x 400 mm rack system is suitable for glasses up to a height of 264 mm for undercounter machines. The rack compartment is adjusted to the glass diameter and glass height in each case. The FRIES rack system L 400 offers versatile use in cleaning, storage and transport. Optional colour-coding makes handling even easier.

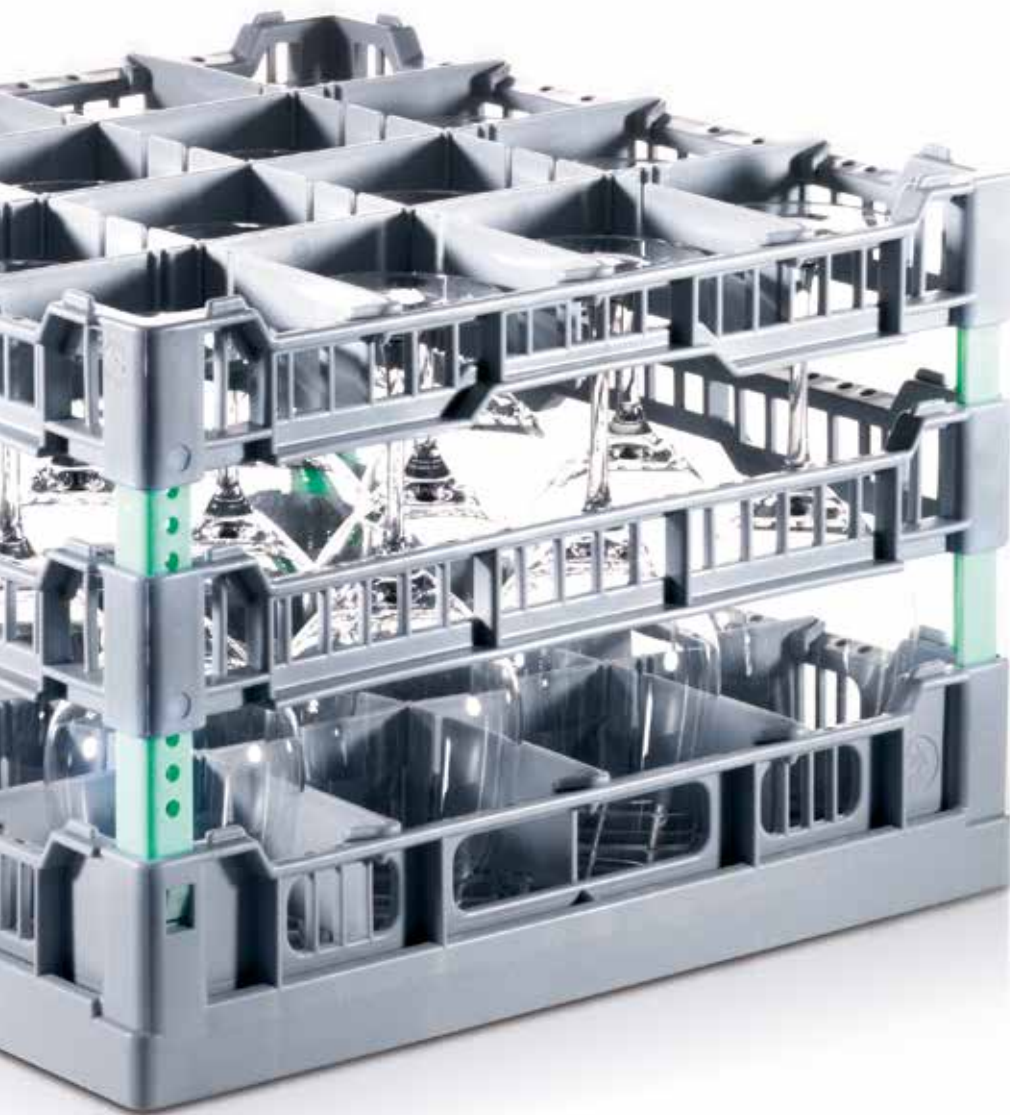

## Rack system L 400 at a glance

- » stackable
- » light-weight
- » easy checking of rack contents
- » good carrying comfort
- » less glass breakage through customisation
- » tilting of glasses as option
- » suitable for transport on Euro pallets

# Rack system L 400

Rack types for glass heights up to a maximum of:

65 mm (LA)

120, 132, 144, 156, 168, 180 (LB)



192, 204, 216, 228, 240 mm (LC)

240, 252, 264 mm (LD3)



## Compartments

**9 compartments**  
(3 x 3)

Compartment size:  
115 x 115 mm

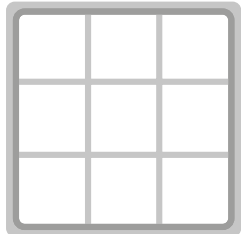

**12 compartments**  
(3 x 4)

Compartment size: 115 x  
88 mm

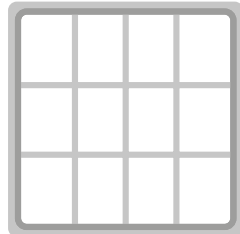

**16 compartments**  
(4 x 4)

Compartment size:  
88 x 88 mm

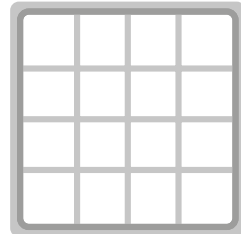

**20 compartments**  
(4 x 5)

Compartment size:  
88 x 68 mm

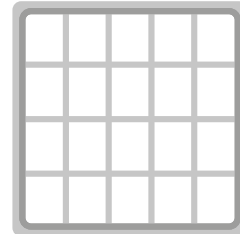

**25 compartments**  
(5 x 5)

Compartment size:  
68 x 68 mm

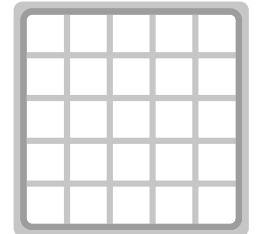

## Accessories for the L 400 rack system

**Drip tray (AW 400)**  
suitable for the counter



**Cover (ABH 400)**  
Height 1.60 m  
for protecting the glasses during  
storage and transport

**Platform cart with drip tray**  
(ROL 400 + AW 400)  
ROL 400 with removable  
drip tray AW 400



# Bistro racks R 350-400

## Rack widths bistro racks:

350 x 350 mm  
390 x 390 mm  
396 x 396 mm  
400 x 400 mm

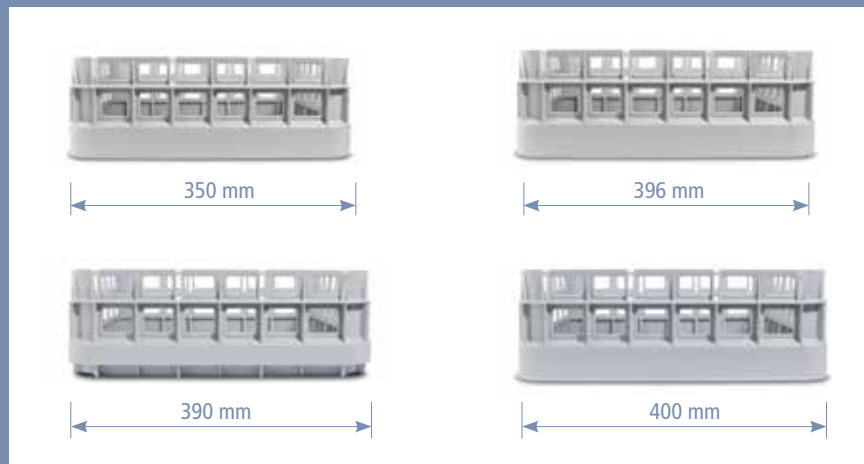

## Rack types

### Bistro rack (R 350)

Rack width: 350 mm  
Internal height: 105 mm



### Bistro rack (R 390, R 396, R 400)

R 390: Rack width: 390 mm  
R 396: Rack width: 396 mm  
R 400: Rack width: 400 mm  
Internal height: 125 mm



## Accessories

### Glasrelax (GR 400)

Terrace insert for tilting the glasses (for R 390-400 only)



### Plate insert (PI 400, PI 350)

Plate inserts for bistro racks  
PI 400 for 9 plates, PI 350 for 8 plates



### Cutlery holder (CBS)



# Examples of use and rack sets

## R 390-1GR 400

R390 equipped with a GR 400 insert



## R 400 + PI 400

R 400 equipped with a PI 400 insert



## PI 400

R 400 equipped with two PI 400 inserts



## R 390-3GR 400

R390 equipped with 3 GR 400



## R396-4GR 400

R396 equipped with 4 GR 400



## Bistro set 396

2 × R 396



4 × GR 400



1 × PI 400



1 × CBS



### Contents

2 R 396 bistro racks, 4 GR 400 glass inserts,  
1 PI 400 plate insert, 1 CBS cutlery holder;  
also available as bistro set 390 + 400

## Bistro set 350

2 × R 350



1 × PI 350



1 × CBS



### Contents

2 R 350 bistro racks, 1 PI 350 glass insert  
and 1 CBS cutlery holder



Rack systems 400  
All advantages of the  
FRIES rack systems

[www.fries-kt.com](http://www.fries-kt.com)

# Rack system 400 x 400

The small all-round rack for various items or the rack system with glass compartments for storage, transport and cleaning.

No one offers more options than us!



**Rack systems 400 x 400**  
More information on the rack systems 400  
[www.fries-kt.com](http://www.fries-kt.com)

## Have you seen this?

Learn more about our large range of products.



**Rack system 500 x 500**  
for gastronomic applications



**Rack system 600 x 400**  
for the logistics, glass hire and catering business



**Rack system 600 x 500**  
for large hood-type and rack conveyor machines



**Gastro & Catering**  
Transport boxes and party plates



**Reusable tableware**  
for sustainable events & to-go meals



### FRIES Kunststofftechnik GmbH

Schützenstraße 19, 6832 Sulz, Austria  
Phone: +43(0)5522 4935 201, Fax: + 43(0)5522 4935 209  
[info@fries.at](mailto:info@fries.at), [www.fries-kt.com](http://www.fries-kt.com)



Packaging



Gastro



Industry racks



Moulding